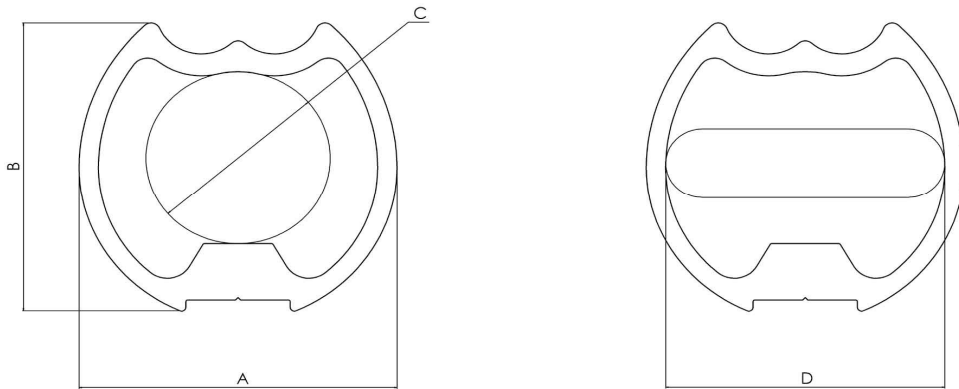

B.P 222, Parc d'Activités.

50550 ST VAAST LA HOUGUE

Tel : (33) 02 33 88 50 22 / Fax : (33) 02 33 23 14 27

Email : info@facnor.com

DIMENSIONS DES MANCHONS - MEASUREMENTS OF THE CONNECTORS

Reference - section	SX 25	SX33	SX 39	SX 47	SX 53
Ref. - enrouleur/furl.system LS-LX	60-70	100-130	165-180	200-260	330
Ref. - enrouleur/furl.system FD	090	170	210	280	
A	25	29	37	47	55
B	23	27	36	48	59
C	13	16	21	32	42
D	22	26	32	42	50

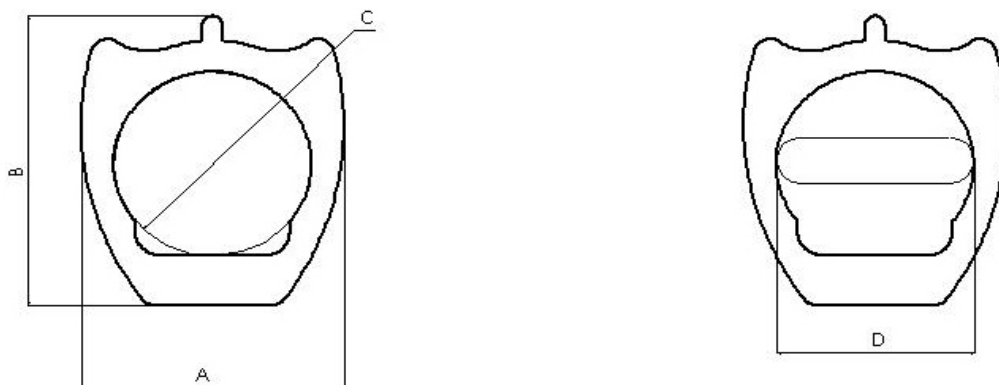

Reference - section	R14	R24	R26	R34
Ref. - enrouleur/furl.system RX	70-130	165-200	260	300
Ref. - enrouleur/furl.system RC	100	180	220	300
Ref. - enrouleur/furl.system FD	110	190	230	310
A	19	22	25	31
B	23	27	30	36
C	14	16	19	22
D	14	16	19	22

Les dimensions sont en mm. / Dimensions are in mm.